

Standard Pop Up Display Sizes

Our standard pop up stand sizes are determined by the number of box sections, that the frame is made up from.

For example: 3x3 Pop Up comprises of three box sections high by three box sections wide.

FRONT

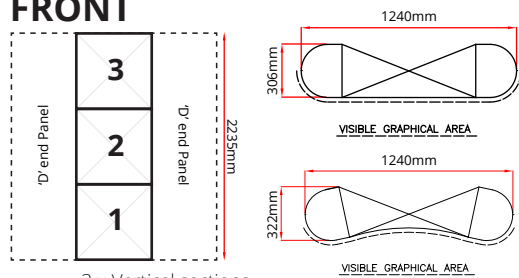

3x1 $\frac{3 \text{ x Vertical sections}}{1 \text{ x Horizontal section}}$

FRONT

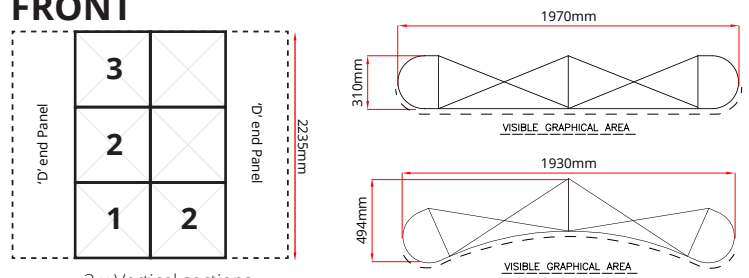

3x2 $\frac{3 \text{ x Vertical sections}}{2 \text{ x Horizontal section}}$

FRONT

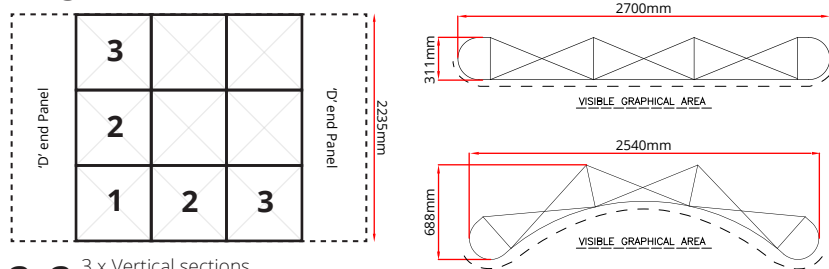

3x3 $\frac{3 \text{ x Vertical sections}}{3 \text{ x Horizontal section}}$

FRONT

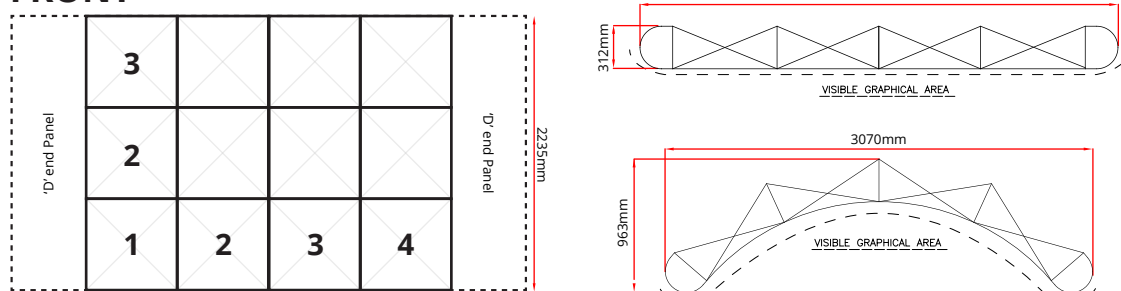

3x4 $\frac{3 \text{ x Vertical sections}}{4 \text{ x Horizontal section}}$

FRONT

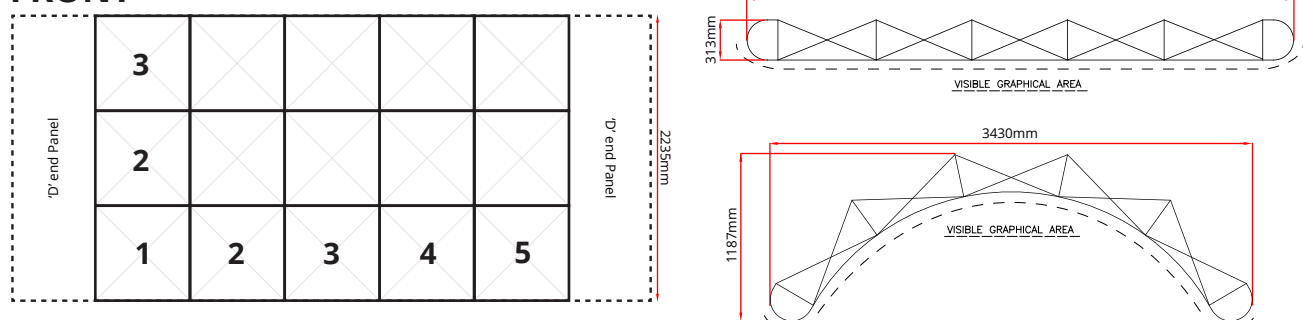

3x5 $\frac{3 \text{ x Vertical sections}}{5 \text{ x Horizontal section}}$

Jumbo Pop Up Display Sizes

Our standard pop up stand sizes are determined by the number of box sections, that the frame is made up from.

For example: 4x3 Pop Up comprises of four box sections high by three box sections wide.

FRONT

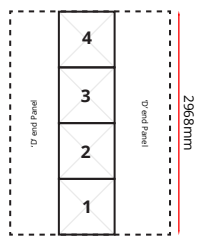

4x1 4 x Vertical sections
1 x Horizontal section

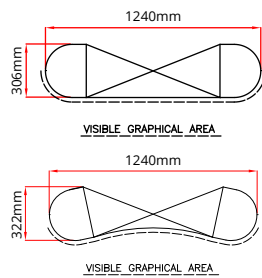

FRONT

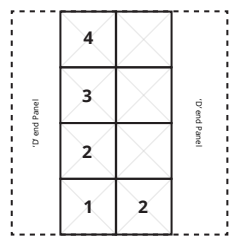

4x2 4 x Vertical sections
2 x Horizontal section

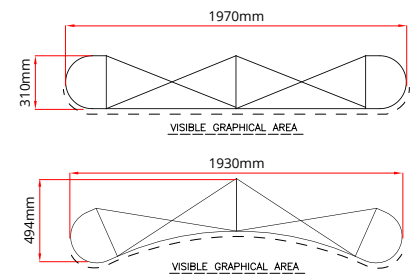

FRONT

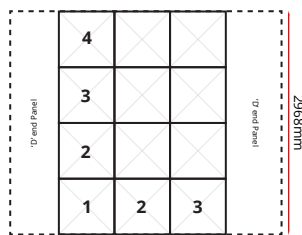

4x3 4 x Vertical sections
3 x Horizontal section

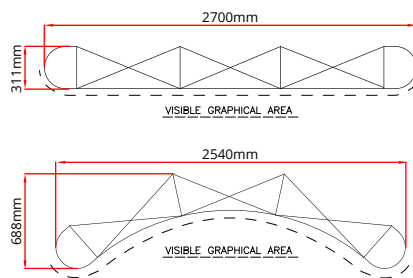

FRONT

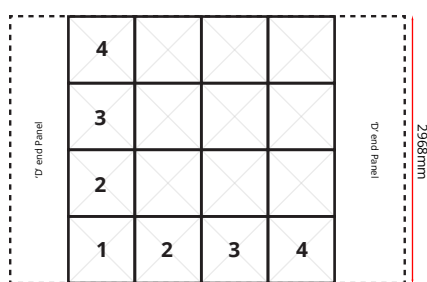

4x4 4 x Vertical sections
4 x Horizontal section

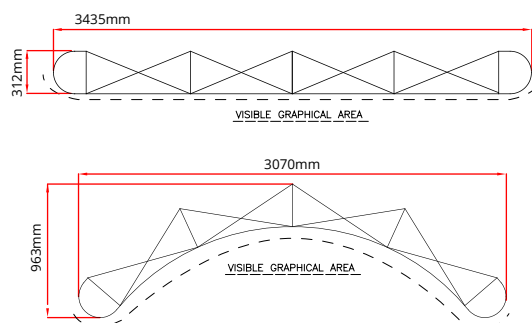

FRONT

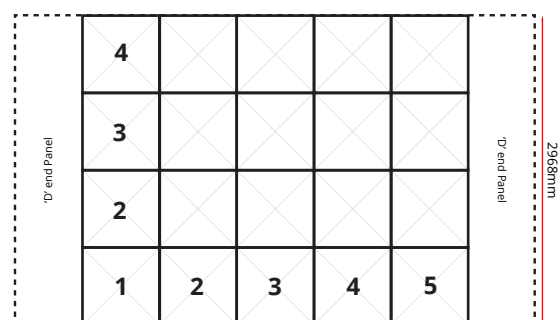

4x5 4 x Vertical sections
5 x Horizontal section

