



01733 511030  
sales@xldisplays.co.uk  
www.xldisplays.co.uk

ENGLISH

# USER MANUAL

## XC / XD SERIES TENTS

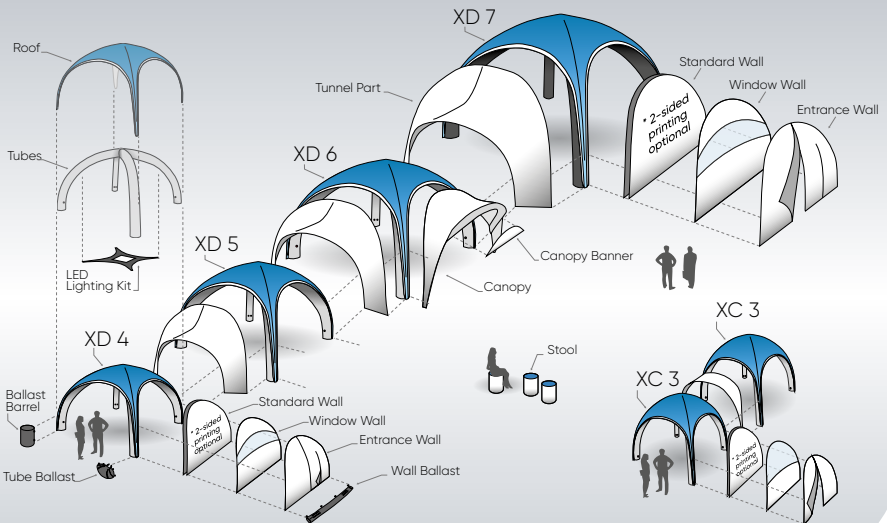

# THANK YOU FOR YOUR TRUST

XL Displays Ltd congratulates you on the purchase of your inflatable X GLOO Event Tent, the modular, lightweight tent system without compressors and poles.

In order to guarantee the perfect operation, optimal function, long product life and your personal safety and the safety of your guests, please note the following:

Before you use your Inflatable Event Tent for the first time, read this user manual carefully and follow all hazard and safety information.

All functions, maintenance and repairs should only be carried out to the degree described in these operating instructions.

Please contact your X GLOO Team for repairs exceeding these instructions!

If you loan your inflatable X GLOO Event Tent to another person, please pass on these instructions and make sure that the person is fully advised regarding the technical aspects of the Event Tent in order to avoid faulty operation.

If you have any further questions, we are always happy to assist you:

**CALL TODAY ON 01733 511030**

<b>1. TECHNICAL DATA</b>	<b>04</b>
<b>2. CONTENTS OF DELIVERY</b>	<b>05</b>
<b>3. SETUP</b>	<b>06</b>
3.1 Lay out the tent	06
3.2 Inflation - deflation - valves - raising	07
3.3 Pumps	09
<b>4. ANCHORING</b>	<b>9</b>
4.1 Tube Ballasts	11
4.2 Water Ballast Barrels	12
4.3 Tent stakes	14
4.4 Anchoring lines/webbing	15
4.5 Wall Ballasts	15
<b>5. ELEMENTS</b>	<b>16</b>
5.1 Walls	16
5.2 Canopy	17
5.3 Tunnel Part	17
5.4 LED Lighting Kit	18
<b>6. PROPER USE</b>	<b>18</b>
6.1 General information	18
<b>7. TAKEDOWN</b>	<b>20</b>
7.1 Release air	20
7.2 Fold	20
7.3 Pack	20
<b>8. STORAGE</b>	<b>21</b>
<b>9. CLEANING</b>	<b>21</b>
<b>10. MAINTENANCE - REPAIR - ASSEMBLY</b>	<b>22</b>
10.1 Material	22
10.2 Removing the roof	23
10.3 Disassembling the One-Pump System	24
10.4 Removing tubes	25
10.5 Reassembling the roof and tubes	25
10.6 Replacing the protection strips	25
10.7 In the event of pressure loss	26
10.8 Repairing a bladder	26
10.9 Replacing a valve	27
10.10 Replacing a bladder	27

# 1. TECHNICAL DATA

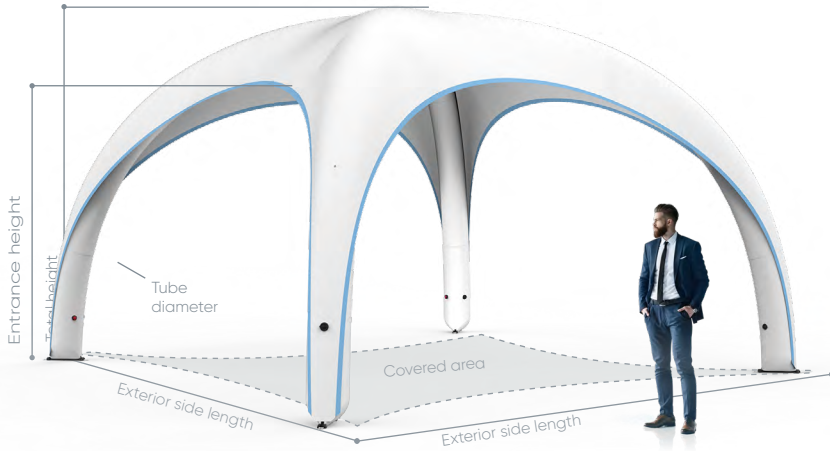

	XC 3	XD 4	XD 5	XD 6
Exterior side length	3,0 m	4,0 m	5,0 m	6,0 m
Entrance height	1,95 m	2,0 m	2,5 m	3,0 m
Total height	2,6 m	2,38 m	3,0 m	3,57 m
Tube diameter	20,0 cm	25,0 cm	31,0 cm	37,0 cm
Weight without Walls	9,32 kg	13,3 kg	18,8 kg	22,5 kg
<b>COVERED AREA</b>				
without Side Walls	5,6 m <sup>2</sup>	7,23 m <sup>2</sup>	11,3 m <sup>2</sup>	16,27 m <sup>2</sup>
with 4 Canopies	-	23,0 m <sup>2</sup>	35,7 m <sup>2</sup>	51,34 m <sup>2</sup>
<b>SETUP</b>				
Hand Pump	10 min	15 min	25 min	30 min
Electric Pump	3-5 min	3-5 min	7-10 min	10-15 min
Operating pressure*	0,35 bar/ 5,1 PSI	0,35 bar/ 5,1 PSI	0,26 bar/ 3,8 PSI	0,26 bar/ 3,8 PSI

\*This data serves primarily as information, since the operation of the overpressure valves is automatic.

All dimensions are approximate.

## 2. CONTENTS OF DELIVERY

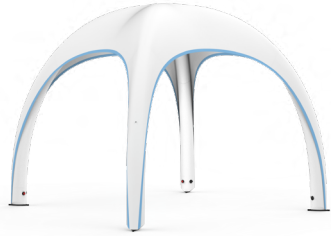

### XC 3

- 1x Anchoring line set (1)
- 1x Repair kit (2)
- 1x Hand pump (3)
- 1x User manual and quick user guide (4)
- 1x Allen key (5)

### XD 4

- 1x Anchoring webbing set (1)
- 3x Repair kit (2)
- 1x Hand pump (3)
- 1x User manual and quick user guide (4)
- 1x 5 mm Allen key (5)
- 1x 4 mm Allen key (5)
- 1x cable tie (6)
- 1x Valve wrench (7)
- 1x Valve adapter (8)
- 1x Replacement bladder (9)

### XD 5/6/7

- 1x Anchoring line set (1)
- 3x Repair kit (2)
- 1x Hand pump (3)
- 1x User manual and quick user guide (4)
- 1x 5 mm Allen key (5)
- 1x 4 mm Allen key (5)
- 1x cable tie (6)
- 1x Valve wrench (7)
- 1x Valve adapter (8)
- 1x Replacement bladder (9)
- 1x Closing rod (10)

# 3. SETUP

## 3.1 LAY OUT THE TENT

Take the tent out of the supplied transport bag and spread it out at your setup location with the roof facing up. It helps to arrange the tent so that the tube ends are laying approximately where they will be when the tent is inflated. This can make the setup process much easier.

In order to reduce the risk of soiling / damaging the tent during the setup process, it is recommended to first spread out the Protection Foil, which can be purchased from X GLOO as an optional accessory..

Remove the protective covers from the tube ends.

**PLEASE NOTE:** The removable protective covers on the tube ends protect the tent from damage. Therefore, in order to prevent leaks, it is strongly recommended to reattach the protective covers before folding up the tent..

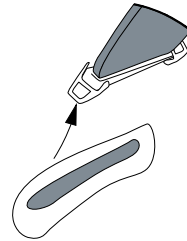
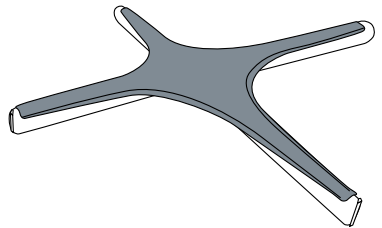

## 3.2 INFLATION - DEFLATION - VALVES - RAISING

The valve for inflation/deflation consists of the socket that is permanently welded to the inner tube and a screw-on valve housing with attached protective cover.

### 3.2.1. INFLATION: XD 4/5/6/7

To inflate the tent, the valve housing, which can be found on the inner side of each tube, must be screwed firmly into the socket. A backflow preventer (red button) in the valve housing prevents the air from escaping again. For it to function properly, the backflow preventer must be in the up position, which may have to be activated by pushing down on it (the same principle as with a ballpoint pen).

XD 4/5/6/7

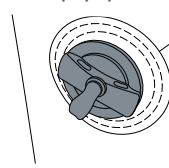

XC 3



Connect one end of the hose to the pump and the other end, with the valve adapter, to the valve by turning it slightly. After inflation is complete, close the valve with the protective cover.

**PLEASE NOTE:** If small folds form in the tube during inflation, it is helpful to shake the tube and bladder. This movement helps bring the bladder back into the optimal position in the tube, allowing it to be inflated to maximum capacity and therefore achieve full stability.

**To deflate**, press the backflow preventer (red button) in the valve housing on each tube until it clicks into place. This allows the air to escape completely.

**PLEASE NOTE:** After deflating, it is recommended to return the backflow preventer to the up position by pushing it again. This ensures that the tent is ready for inflation next time you want to use it.

### 3.2.2. INFLATION: XD 4/5/6/7 WITH ONE-PUMP SYSTEM

**PLEASE NOTE:** Before inflating, be sure that the backflow preventers on the valves, found on the inner side of each tube, are closed/in the up position.

To inflate, use the central inflation hose, which can be found on the outer side of one of the four tubes. Connect one end of the hose to the pump and the other end to the inflation hose by means of the valve adapter by turning it slightly (bayonet valve system).

When disconnecting the pump after inflation, it is normal for the excess air in the inflation hose to escape. Finally, close the valve with the protective cover.

**To deflate**, please refer to 3.3.1.

### 3.2.2. INFLATION: XC 3

To inflate, the valve housing must be first screwed tightly into the socket. The backflow preventer in the valve prevents the air from escaping.

**To deflate**, unscrew the entire valve housing from the socket..

### 3.2.3 OVERPRESSURE VALVE: XC 3 | XD 4/5/6/7

On each tube there is a red overpressure valve that automatically opens as soon as the maximum air

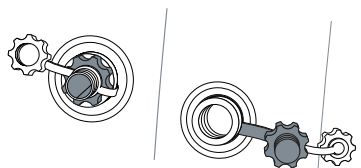
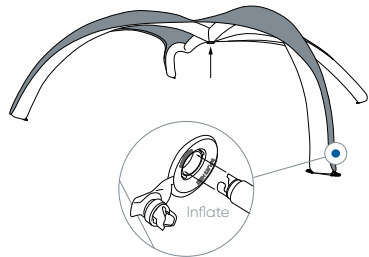
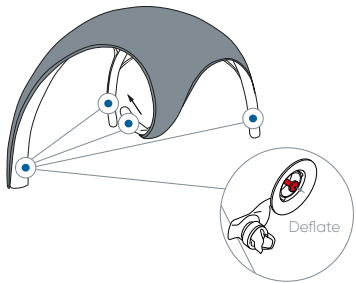
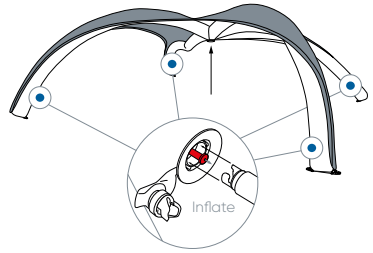

pressure in the tube has been reached. The overpressure valve prevents the tube from bursting if the air pressure inside is too high, and because it is a safety-related part, special attention should be given to it.

Before inflation, every overpressure valve should be checked to ensure that it is functioning properly. To do this, unscrew the valve housing from the socket and check to make sure that the spring can be pressed in. Make sure that the valve is properly screwed closed again after testing.

Sand or dirt can jam the spring and valve, which may prevent the valve from functioning correctly.

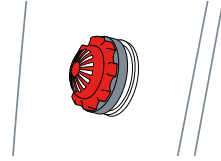

### 3.2.4 RAISING: XC 3 | XD 4/5/6/7

**PLEASE NOTE:** Raising the tent from the ground requires some assistance. Before the tubes are fully inflated, the middle of the tent – where the tubes intersect – must be actively lifted off the floor. This prevents the tent from possibly being damaged from being inflated invertedly.

When setting up the tent in sandy terrain, make sure that no grains of sand get into the hoses or pumps through valve openings, which could lead to damage or leaks.

For the tent to appear optically perfect, the tubes should be aligned by hand after inflation and the roof readjusted on the tubes if necessary.



**PLEASE NOTE:** The specified maximum air pressure must not be exceeded and is reached when the overpressure valves open and the excess air begins to escape.



## 3.3 PUMPS

### 3.3.1. INFLATION WITH THE ELECTRIC PUMP

Screw the threaded end of the supplied hose onto the discharge opening of the pump.

Plug the power cable into an electric socket. Note that the Bravo 2000 has a booster that has to be activated using the switch on the pump. Please also observe the instructions and information supplied with the electric pump.

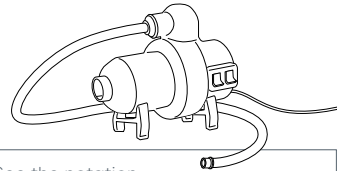

See the notation on the hose connection::

**OUT** = inflate  
**IN** = deflate

### 3.3.2. INFLATION WITH THE HAND PUMP

The hand pump included in the contents of delivery is equipped with various adapters that allow connection to different valves. The hose should not be kinked or compressed as this could result in leaks or breakage!

**NOTE FOR INFLATING THE CANOPY:** Two pump hoses are always included with delivery. These can be connected so that the canopy valves can be reached for inflation.

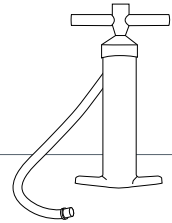

**TIP:** Note the valve plug at the top of the pump body::

**OPEN** = pumps only on the down stroke  
(Single Action)

**CLOSED** = pumps on both the up and down stroke  
(Double Action)

## 4. ANCHORING

The X GLOO XD and the XC series have been developed to be mobile and modular lightweight tents. Despite their low weight, and the associated relatively low risk potential, the following information must be read before use and diligently observed to prevent damage to property and personal injury.

### GENERAL INSTRUCTIONS

Depending on the nature of the terrain, the appropriate anchoring accessories must be used:

- On firm, packed soil, the X GLOO Anchoring Set (tent stakes) for the appropriate tent size can be used.
- On snow or sand, the Snow Anchors or Sand Anchors are to be used in place of tent stakes, respectively.
- On asphalt and similar hard surfaces, the tent must be weighted down using ballasts sufficient for the tent size and maximum expected wind speed.

The table in the **wind speed certificate on the next page** shows the type and quantity of ballasts to be used, depending on the expected maximum wind speed and the tent size.

# WIND SPEED CERTIFICATE

## FORCES

- BASIS:
- Wind Speed: 1 m/s = 3,6 km/h
  - Density of the flowing medium: 1.224 kg/m<sup>3</sup>
  - Drag Coefficient: 1 (Safety factor of 1,2; estimated actual drag coefficient of 0,6
  - Friction of Ballast Barrel and ground: 1 [material: rubber-to-asphalt]

Size	Surface Area with Side Wall
XC 3	5,4 m <sup>2</sup> (58 ft <sup>2</sup> )
XD 4	8,5 m <sup>2</sup> (91,5 ft <sup>2</sup> )
XD 5	13 m <sup>2</sup> (1399 ft <sup>2</sup> )
XD 6	19 m <sup>2</sup> (204,5 ft <sup>2</sup> )
XD 7	26 m <sup>2</sup> (2798 ft <sup>2</sup> )

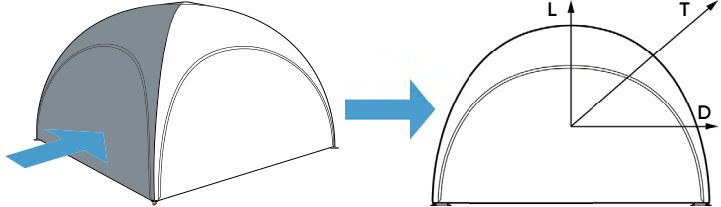

Size	Drag (D) [daN]			Lift (L) [daN]			Total Force (T) [daN]		
	30 km/h wind speed (18.7 mph)	40 km/h wind speed (25 mph)	60 km/h wind speed (37.3 mph)	30 km/h wind speed (18.7 mph)	40 km/h wind speed (25 mph)	60 km/h wind speed (37.3 mph)	30 km/h wind speed (18.7 mph)	40 km/h wind speed (25 mph)	60 km/h wind speed (37.3 mph)
XC 3	22,8	40,5	91,3	11,4	20,3	45,7	25,5	45,3	
XD 4	24,2	51,7	115,0	11,3	39,6	60,8	35,5	68,0	175,8
XD 5	37,0	79,1	175,9	17,6	42,0	195,0	54,7	121,2	271,0
XD 6	54,1	115,6	257,1	25,4	60,6	136,8	79,6	176,2	305,7
XD 7	74,1	158,3	351,9	34,6	82,4	186,2	108,7	240,0	

## BALLAST RECOMMENDATIONS

Below are shown the weights necessary to secure one tube on your X GLOO tent during high winds. At a minimum, this weight should be used on all tubes facing into the wind. However, in order to achieve the most security and stability we strongly recommend that you secure all four tubes on your X GLOO tent.

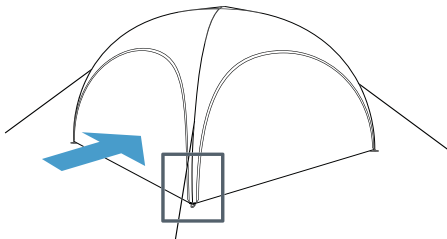

Size	Weight per Tube		
	30 km/h wind speed (18.7 mph)	40 km/h wind speed (25 mph)	60 km/h wind speed (37.3 mph)
XC 3	13 kg (28 lbs)	23 kg (49 lbs)	
XD 4	18 kg (39 lbs)	34 kg (75 lbs)	89 kg (196 lbs)
XD 5	27 kg (59 lbs)	60 kg (132 lbs)	135 kg (297 lbs)
XD 6	40 kg (88 lbs)	88 kg (194 lbs)	153 kg (337 lbs)
XD 7	54 kg (119 lbs)	120 kg (264 lbs)	

### X GLOO Ballast System(s) per Tube

Size	30 km/h wind speed (18.7 mph)	40 km/h wind speed (25 mph)	60 km/h wind speed (37.3 mph)
XC 3	1x Tube Ballast	2x Tube Ballasts	
XD 4	1x Tube Ballast	2x Tube Ballasts	1x Ballast Barrel
XD 5	1x Tube Ballast	2x Tube Ballasts	2x Ballast Barrels
XD 6	2x Tube Ballasts	1x Ballast Barrel	2x Ballast Barrels
XD 7	1x Ballast Barrel	2x Ballast Barrels	

- In windy conditions, be sure to orient the tent against the wind so that it offers the least resistance. Canopies, in particular, should not be aligned facing into the wind, nor should open sides of the tent face into the wind when the side of the tent away from the wind is closed with a wall. Wind loads can be significantly reduced by removing the walls and canopies.
- Exposure to wind gusts which exceed the maximum permissible wind speed can lead to structural damage to the tent that is not covered by the warranty.
- In the event of a drastic deterioration in the weather, all valves must be opened to let the air out of the tent and thus avoid greater damage. The deflated tent should be weighed down to prevent it from being taken by the wind.

## 4.1 TUBE BALLASTS

Each Tube Ballast Set includes four ballasts. Each ballast contains a water bladder for filling with water.

### 4.1.1. FILLING WITH SAND/GRAVEL

- When filling the ballasts with sand or gravel, the water bladders must first be removed so that they do not become damaged.

### 4.1.2. FILLING WITH WATER

- Open the ballast cover and pull out the water bladder until the fill valve is visible.
- Included in the Tube Ballast Set are a hose and various faucet adapters. Attach the hose to the faucet using the correct adapter.
- Open the fill valve, insert the other end of the hose and fill the bladder with water.
- When full, remove the hose and close the valve and the velcro on the ballast cover.

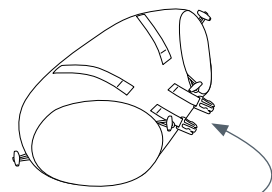

2 CLIPS beim **XC 3**  
Nur 1 CLIP beim **XD 4/5/6/7**

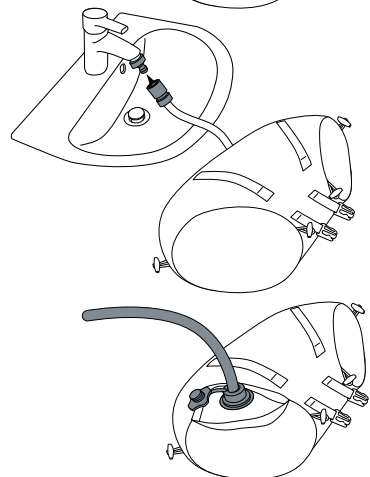
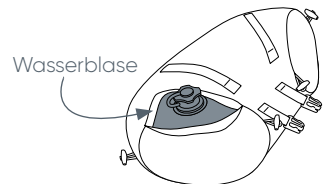

### 4.1.3. CONNECTING TUBE BALLASTS TO THE TENT

Tube ballasts can be attached to the inside or outside of the tubes, as conditions require.

#### CONNECTING TO AN XD 4/5/6/7

Stellen Sie sicher, dass die gummierte Seite der Ballastierung nach unten zeigt.

Make sure that the rubber-reinforced side of the ballast is facing the ground. On the ballast, bring the end of the webbing with the buckle insertion part up through the anchoring ring on the tube end (a) and then through the webbing loop on the Tube Ballast (b). Connect the hook part of the buckle into the insertion part of the buckle and tension the webbing so that the Tube Ballast is snug against the anchoring ring. This is how you achieve the best stability and force transmission. (c)

#### CONNECTING TO AN XC 3

Use the buckles on the Tube Ballasts to connect them to the tube ends on the tent. Make sure that the rubber-reinforced side of the ballast is facing the ground.

### 4.1.4. CONNECTING MULTIPLE TUBE BALLASTS TO ONE TUBE

To secure the tent in strong winds, multiple ballasts can be attached to each tube end. Arrange the Tube Ballasts next to each other and connect them to one another using the plastic toggles. Then attach the buckles on each ballast to the tube ends of the tent as described in 4.1.3. The Tube Ballast can alternatively be placed on top of one another.

XD 4/5/6/7

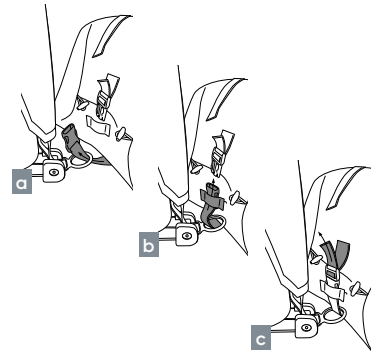

XC 3

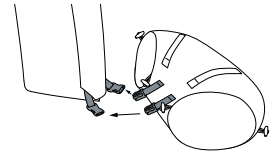

AM BEISPIEL XC 3

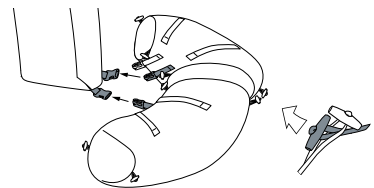

## 4.2 WATER BALLAST BARRELS

Especially suited for hard ground surfaces, Water Ballast Barrels can be used as tent anchors, seating or both.

### 4.2.1. FILLING

Make sure the the check valve tab in the opening at the bottom of the barrel is closed. To do this, pull the check valve forward with one finger. This will ensure that nearly no water can escape when removing the hose after filling (a).

- When filling with water, the upper opening should

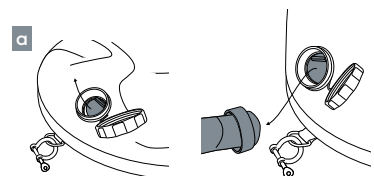

initially remain open (with the check valve pushed back into the barrel) so that the air can escape when filling the barrel (b).

- Next, pull the check valve tab forward (c) before filling any remaining space in the barrel with air. It is not necessary to connect the pump directly to the top opening. Instead, the easiest way is to hold the hose of the running pump against the edge of the check valve in the upper opening (d).
- Finally, tightly close the cover on the upper opening (e).
- To transport the Water Ballasting Barrel, either lift it by the handles with two people or tip it onto the hard bottom edge and roll it.

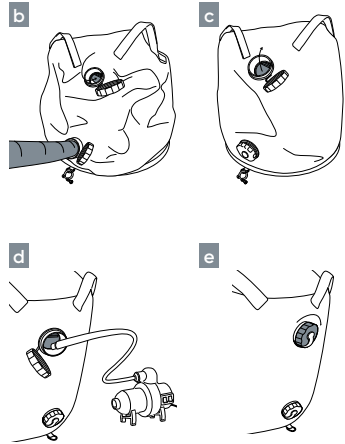

#### 4.2.2. CONNECTING TO A TENT

The eyelets on the Water Ballast Barrel bases can be used to connect them to the rings on the tube ends by means of the included shackles. You can attach up to two Water Ballast Barrels directly to the rings on the tent base.

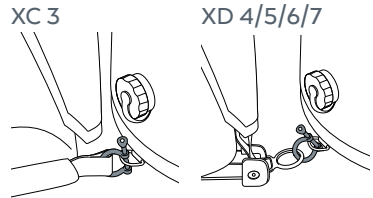

If three barrels are to be connected to each tube end, they must first be attached to a no-rub mat. The tent can then be attached to the no-rub mat to transmit the force. With this arrangement the tent is indirectly connected to the barrels.

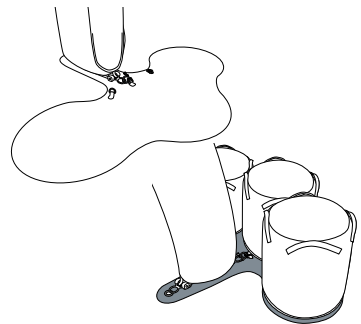

#### 4.2.3. EMPTYING

To empty the barrels, unscrew the cover on the bottom opening and push in the check valve tab so that the water can run out by itself.

#### 4.2.4. DIGITALLY-PRINTED COVER

The digitally-printed cover can be pulled completely over the filled barrel and then zipped closed..

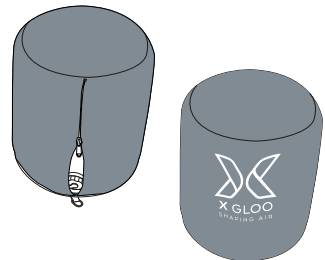

## 4.3. TENT STAKES

The graphic below shows which size/type tent stake should be used at which position.

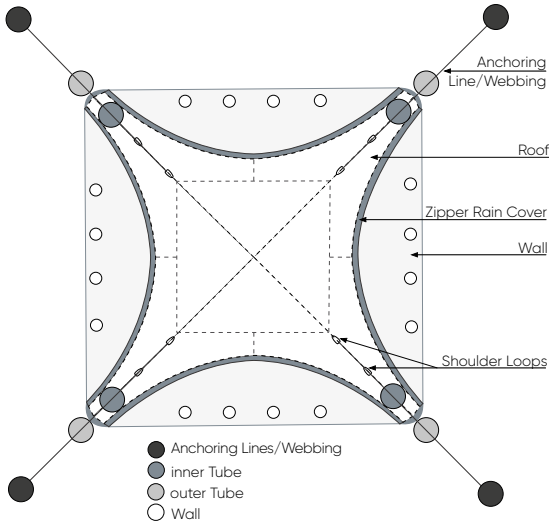

### FOR XC 3 / XD 4

Tent Stakes	Qty.	Use
300 mm L	16 St.	Walls + inner Tube
500 mm L	4 St.	outer Tube
Speed Cinch	4 St.	Anchoring Webbing

### FÜR XD 5 / 6

Tent Stakes	Qty.	Use
300 mm L	16 St.	Walls + inner Tube
500 mm L	8 St.	outer Tube + inner Tube
Speed Cinch	4 St.	Anchoring Webbing

### FÜR XD 7

Tent Stakes	Qty.	Use
300 mm L	16 St.	Walls
500 mm L	8 St.	Walls + inner Tube
800 mm L	4 St.	outer Tube
Speed Cinch	4 St.	Anchoring Webbing

When using tent stakes, it should be noted that the actual anchoring strength achieved depends largely on the nature of the ground surface. Because of this, no general information can be provided about which wind loads can be absorbed with which number of stakes.

It is always important to drive in the tent stakes an angle slightly toward the tube end to help prevent them from being pulled out while the tent is in use.

## 4.4 ANCHORING LINES

Anchoring lines must be used to ensure the structural stability of the tent!

- Push the loop end of the anchoring line through the shoulder loop on the tent roof.
- Insert the tail end of the anchoring line through the loop end and pull it through until the anchoring line is snugly attached to the shoulder loop.
- Secure the tent by connecting the anchoring line with a tent stake hammered into the ground at least two meters away from the tube end and tension the line with the line tensioner.
- Repeat this process on the other three tubes.

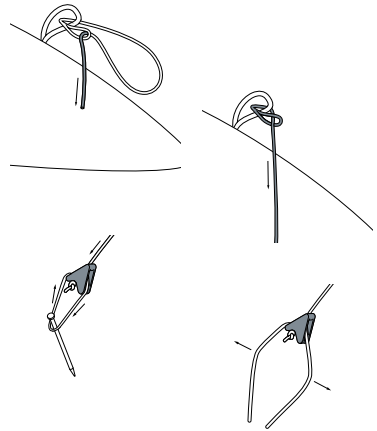

## 4.5. WALL BALLASTS

The Wall Ballasts can be filled with water or sand/gravel and can be connected to the wall using the attached toggles.

### FILLING WITH WATER

- Open the velcro on the ballast cover and pull out the inner water bladder until the fill valve is visible.
- There is a water bladder inside each ballast cover for filling with water. When filling the ballasts with sand or gravel, the water bladders must first be removed so that they do not become damaged.
- Included in the Tube Ballast Set are a hose and various faucet adapters. Attach the hose to the faucet using the correct adapter.
- Open the fill valve, insert the other end of the hose and fill the bladder with water.
- When full, remove the hose and close the valve and the velcro on the ballast cover.
- Connect the four plastic toggles on the ballast to the large grommets on the wall. When doing so, make sure that the rubber-reinforced side of the Wall Ballast is facing down. For securing walls on XD 5, XD 6, XD 7 tents, the use of multiple wall ballasts on each wall is recommended.

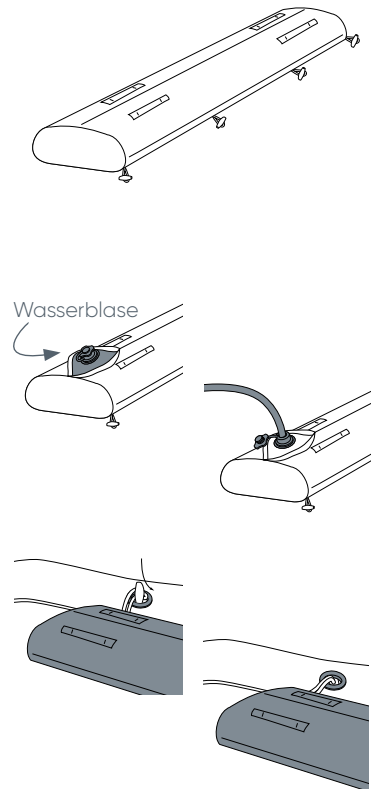

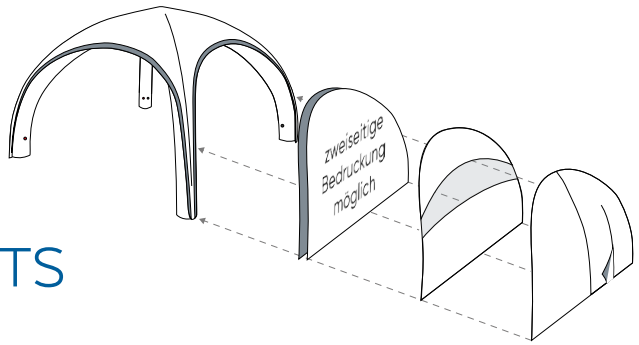

## 5. ELEMENTS

### 5.1. WALLS

Four types of walls are available: window walls, entrance walls, standard walls and double-sided standard walls..

#### 5.1.1. ATTACHING THE WALLS

Attach the wall to the tent using the zippers on the left and right sides. Close the zippers from the bottom upward so that they meet at the top of the wall.

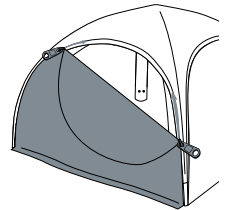

#### 5.1.2. ATTACHING THE WALLS WITH THE CLOSING ROD

To make it easier to open and close the side walls, XD 5/6/7 tents are delivered with a closing rod. The hook of the closing rod can be hooked into the zipper pullers for opening and closing.



The walls can also be attached inside-out. This makes it possible to have the printed side of a wall face either towards the inside or outside of the tent.

In the event of wind, the zippers must always be closed completely, even during setup, as otherwise they can be damaged by wind loads being put on individual teeth of the zipper.

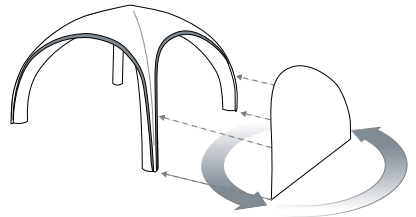

#### 5.1.3. OPENING AND SECURING THE ENTRANCE WALL

Open the zipper in the middle of the entrance wall and gather each side together. On each side of the entrance wall you will find a toggle on a length of cord. Fasten each side by inserting the toggle through the loop of cord across from it..

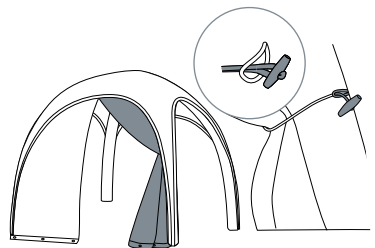



## 5.2. CANOPY AND CANOPY BANNER (XD)

The canopy can be used to extend the covered area of the tent.

Attach the canopy to the tent roof using the zippers.

To prevent the canopy and roof skin from slipping in the wind, attach the velcro strips on each side of the canopy to the corresponding velcro on the tent tubes, which are located under the roof of the tent (a / b).

The canopy can then be inflated by means of a valve found on the left side of the front tube.

Lift the middle of the front tube slightly so that the bladder inside can be filled along its full length.

**PLEASE NOTE:** The red overpressure valve automatically opens as soon as the maximum air pressure in the front tube has been reached..

Finally, attach the canopy banner (if desired) into the zipper on the upper part of the front tube.

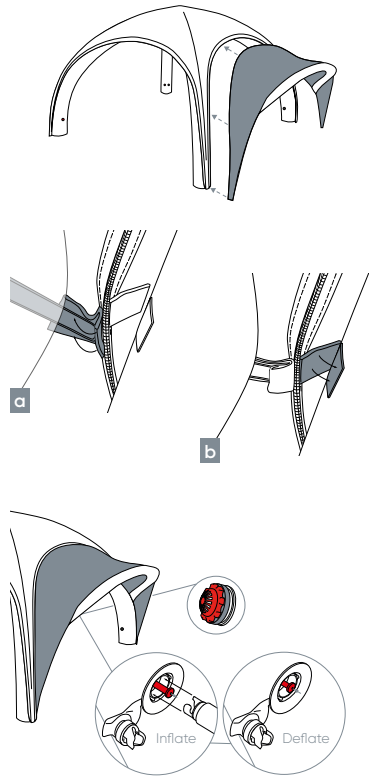

The canopy is equipped with a second zipper in order to be able to close the tent using a wall while still keeping the canopy attached.

Any variety wall can be attached using this zipper. To make the process of connecting the wall easier, it is recommended to first let some air out of the canopy.

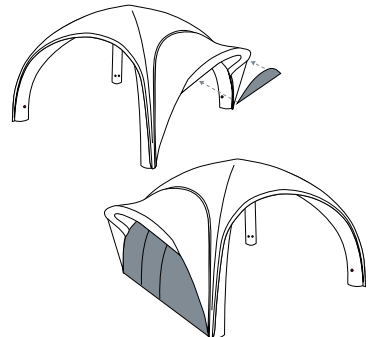

## 5.3. TUNNEL PART

The tunnel part is for connecting two or more X GLOO tents to one another. The zippers for attaching walls also serve to attach tunnel parts or canopies. The principle is the same.

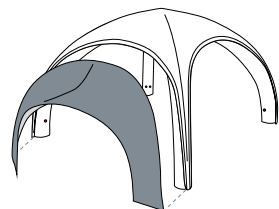

## 5.4. LED LIGHTING KIT

### 5.4.1. ATTACHING THE LED LIGHTING KIT

- As soon as the tent is set up, loop the long end of webbing connected to the LED light up over the tube intersection. Connect both ends of the buckle and then tighten the webbing.

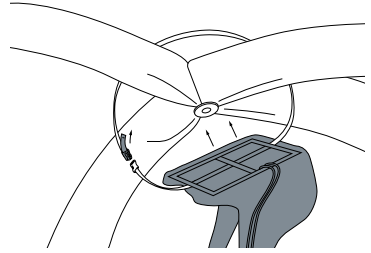

- Connect the four corners of the LED lighting mount to the tent by attaching the plastic toggles to the four loops on the inside of the tubes.

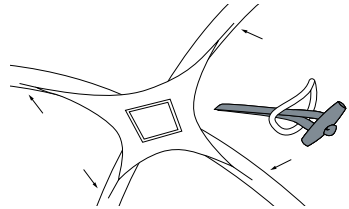

- Tuck the power cable between the roof and one of the tubes starting at the tube intersection and continuing all the way to the ground.
- Set the ballast and dimmer on the ground.

Disassembly of the LED Lighting Kit follows the same steps in reverse. Be sure that the X GLOO LED Lighting Kit does not fall on the ground while deflating the tent..

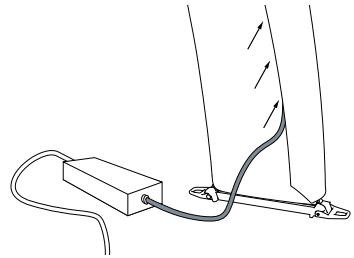

## 6. PROPER USE

### 6.1 GENERAL INFORMATION

- X GLOO tents are not intended for continuous use and should be inspected for wear or damage after every event.
- X GLOO tents are not intended to bear large snow loads. In case of snowfall the accumulating snow must be regularly removed from the roof of the tent. If the tent is to be left unattended and snowfall is called for, then the tent should first be deflated or the tube intersection at the top of the tent securely supported.
- All X GLOO tents are made of certified flame-retardant materials. Nevertheless, the materials are still flammable and can burn when the source of fire is sufficiently strong.
- Keep tents away from open fires and heat sources.

## FIRE PROTECTION CLASSIFICATION (see also X GLOO certificates):

- DIN 4102-B1 (Abb.: B1) Controls testing and requirements on the reaction to fire of building materials. German norm, used in most European countries.
- CPAI 84-95, Section 6 Specification of the American Association of Sailcloth Materials for the assessment of flame-retardant materials used in (event-) tents. The certification according to CPAI 84 fulfills the international requirements for flame resistance in tent products and includes similar test criteria like DIN 4102-B1 or NFP 92501-7M2. Although X GLOO Tents are in use worldwide at tradeshows and events, we reserve the right not to certify the tent according to the national norms of each country.
- Keep all valves free of sand and dirt, and clean them when necessary in order to prevent faulty operation and pressure loss.
- The tents can be damaged when sharp objects (e.g. knives, tools) penetrate the tubes, leading to leakage and loss of pressure. Handle with appropriate care. In extreme cases, damage to the tube material can cause it to burst, even under normal operating pressure!
- Extreme variations in temperature (day and night) or long-term continued use can lead to loss of air pressure through the overpressure valves which requires the reinflation of the tubes.
- The protective strips on the bottom of the tubes on the XC 3 can wear down when the tent is set up on rough terrain and wind causes it to shift around, and should therefore be regularly checked for wear and replaced as necessary before the tubes themselves become damaged.

## MAXIMUM WEIGHT LOOPS

The loops on X GLOO tents have been designed to bear the hanging loads described below when the tents are properly set up and anchored. The user shall be held liable for any damage to property or injury to persons. X GLOO GmbH & Co. KG assumes no liability.

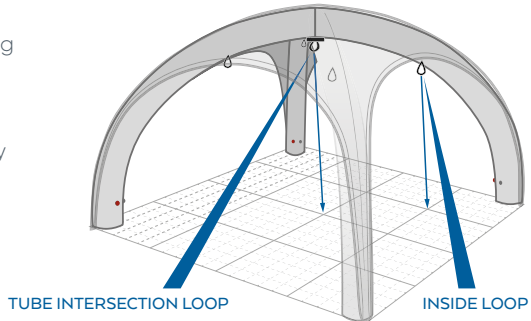

Size	Maximum Weight per Inside Loop	Maximum Weight Tube Intersection Loop	Maximum Total Combined Weight
<b>XC 3</b>	5 kg (11 lbs)	10 kg (22 lbs)	30 kg (66 lbs)
<b>XD 4</b>	5 kg (11 lbs)	15 kg (33 lbs)	35 kg (77 lbs)
<b>XD 5</b>	5 kg (11 lbs)	20 kg (44 lbs)	40 kg (88 lbs)
<b>XD 6</b>	5 kg (11 lbs)	20 kg (44 lbs)	40 kg (88 lbs)
<b>XD 7</b>	5 kg (11 lbs)	25 kg (55 lbs)	45 kg (99 lbs)

# 7. TAKEDOWN

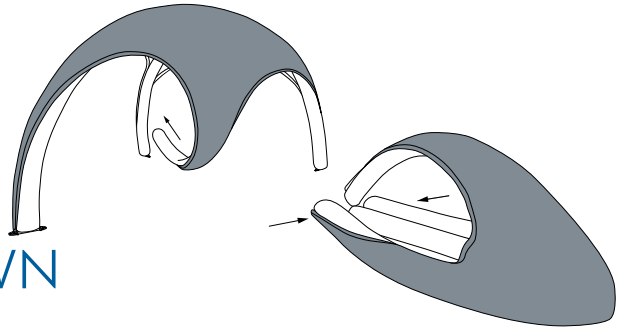

## 7.1 RELEASE AIR

- First remove all optional elements (walls, canopies, etc.) that are attached to the tent.
- Open the valves on each tube.
- (see section 4-7). The air will escape within a few minutes.
- Slide the protective covers onto the tube ends.

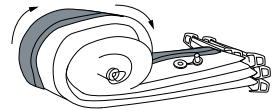
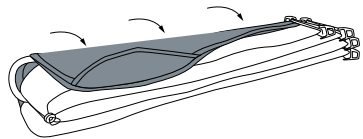
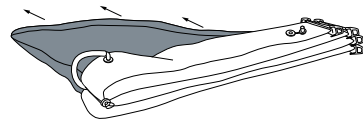
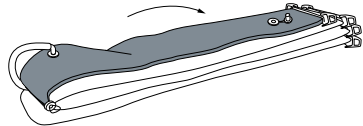
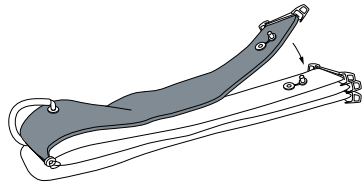
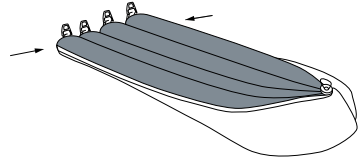

## 7.2 FOLD

- Turn the tent inside-out so that the tube intersection loop is facing outwards.
- Lay the tubes on top of one another with the valves facing upwards. The roof should be drawn outwards in large folds.
- Wait a few minutes for the last of the air to escape, and then roll up the tent starting from the roof and moving down to the tubes.

## 7.3 PACK

- Place the tent in the supplied transport bag. The walls can be packed safely in the optionally-available side wall bag..

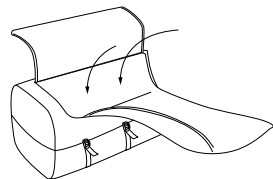

## 8. STORAGE

- X GLOO Tents must not be packed and stored while wet. This can cause mold stains and mildew. The dye on digitally-printed tent parts could also rub off when stored in a damp place.
- X GLOO Tents must never be left in a vehicle (for example) in direct sunlight, as exposure to extreme heat can lead to damage to tent materials or to the windows in window walls permanently sticking together.
- X GLOO Tents must be stored below 20 ° celsius. Otherwise, the material coating can be damaged and the water resistance can be lost.
- Avoid pressure spots (e.g. do not lean on the tent with your knees while folding it or store it under heavy objects).
- At temperatures below 0 ° celsius, sharp folding of materials can damage elements. Take special care care with the window walls in low temperatures and pack them carefully.

## 9. CLEANING

Dirty tents can be cleaned.

If your tent is dirty, first clean it while it is dry.

In order to avoid damage to the material coating, the material should only be cleaned with warm water (or a mild soapy solution if necessary), and a cloth or soft brush. Do not use solvents, washing machines or steam cleaning!

In order not to damage the coating, the materials should only be cleaned with warm water (or a mild soapy water) together with a soft brush – or even better with a cloth. Do not use solvents, washing machines or steam cleaning!

The tent should be subjected to a visual and functional inspection at least once a year by a qualified person. During this inspection, the tent should be inflated in order to check all pressure-bearing parts for tears, punctures, delaminations, or damage from heat or chemical exposure.

All functions, maintenance and necessary repairs should only be carried out to the extent described in this owners manual. Please contact your X GLOO Team about repairs exceeding these instructions!

# 10. MAINTENANCE - REPAIR - ASSEMBLY

- Maintenance and repairs should only be carried out by the manufacturer or an authorized X GLOO Service Center.
- Depending on the frequency of use, the X GLOO Tent should be periodically inspected for chafing and damage and necessary repairs carried out in a timely fashion.
- Re-waterproofing is not possible.

## 10.1 MATERIAL

- All materials used have been carefully selected for their resistance to change from light exposure and have been subjected to rigorous tests. Nevertheless, the material may change color (fade) if there is strong UV exposure (when set up at high altitudes or through a long, uninterrupted period of use). It is not possible to accurately predict when fading may become visible, due to the different influencing variables. White material also tends to yellow through UV exposure and exposure to dust and dirt.
- The materials used are waterproof, the essential seams sealed with sweatband. Nevertheless, water can penetrate in the event of heavy driving rain or prolonged precipitation, especially through zippers.
- Electrical/electronic devices and moisture-sensitive products must be protected from water exposure to water, and their use is at the discretion and risk of the user.
- Compared to the dyed X GLOO material, which is available in the standard colors black, white, gray, red and blue, all other colors and designs are applied by digital printing to one side of a white material. Due to the nature of the digital printing process, the back (unprinted) side of the material remains white or, depending on the amount of light shining through it, slightly transparent.

The tent can be disassembled into individual parts (roof and tubes). This means that the individual parts can be replaced, repaired and used again.

## 10.2 REMOVING THE ROOF

Das The roof can be separated from the tubes.

### 10.2.1 XD 4/5/6/7

- First, loosen the strap adjusters on the webbing found under the roof at the bottom of each of the four tubes (a).
- Next, unhook all cords from the roof-tube connectors by lifting one of the points in the connector and then unthreading the cord..

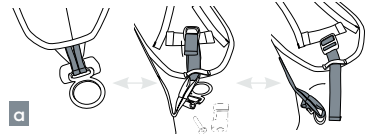

### IF THE TENT IS EQUIPPED WITH THE ONE-PUMP SYSTEM:

- Open the reusable cable tie that attaches the one-pump inflation hose to the air distributor. To do this, lift the locking tab on the cable tie using a flat tool such as a small flathead screwdriver (c) and then slide the inflation hose off of the distributor (d).

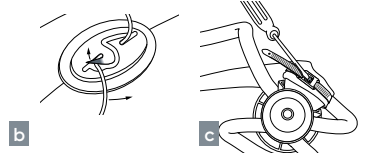

### REASSEMBLING THE ROOF AND TUBES

- First, hook the cords on the inside of the roof into the roof-tube connectors found on all tubes (e).
- Next, connect the webbing to the strap adjusters found near the tube ends between the roof and tubes (f). (Adjust the length of the webbing so that there is about 2.5 cm of space between the roof end and the parts for closing the tube end) (g).

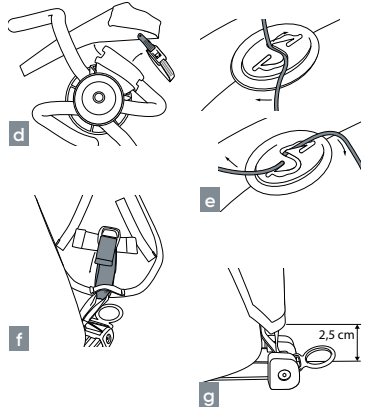

### IF THE TENT IS EQUIPPED WITH THE ONE-PUMP SYSTEM:

- Re-connect the inflation hose to the air distributor using the reusable cable tie (h).

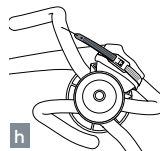

### 10.2.2 XC 3

- First, locate the plastic toggles which connect the roof to the bottom ends of the tube and push these out of the connecting loops (i).
- Next, unhook all cords from the roof-tube connectors by lifting one of the points in the connector and then unthreading the cord (j).

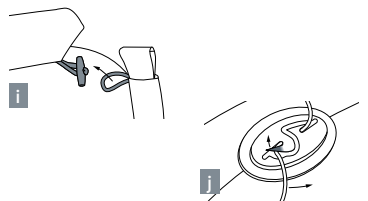

## 10.3 DISASSEMBLING THE ONE-PUMP SYSTEM

- First, open the reusable cable tie that attaches the one-pump inflation hose to the air distributor. To do this, lift the locking tab on the cable tie using a flat tool such as a small flathead screwdriver and then slide the hose off of the distributor (a).
- Next, disconnect the valve connector which connects the air distributor hose to the valve on the tube by slightly lifting the catch using a flathead screwdriver and simultaneously turning the valve connector counterclockwise (b).
- Unscrew the hex socket screw which fastens the air distributor and remove the air distributor (c).
- Should it be necessary to separate a valve connector and/or one of the distributor hoses which connect the air distributor to the valve connector, this is essentially done by simply pulling the hoses off the adjacent components.
- To do this, first remove the outer cap on the air distributor from the distributor itself (d). If you then want to disconnect the hose from the rest of the air distributor, screw it clockwise onto the distributor, while at the same time pulling it away from the distributor. The same process applies for disconnecting the hose from the valve connector. (If you try to unscrew the hose by turning it counterclockwise, the spiral shape of the hose would only pull tighter and make it difficult to pull the hose off.)
- The valve itself can be unscrewed from the socket on the tube by using the valve wrench supplied with the tent (e). When screwing the valve back into place, it is essential to ensure that it is screwed in as far as possible. This requires some extra force to be applied.
- At the same time, is important to make sure that the final position of the valve for connecting the One-Pump System to the upper end of the tube is not random. Instead, make sure that the two notches on the outside edges of the valve are facing the tube ends. (f).

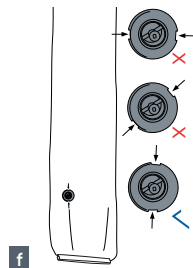
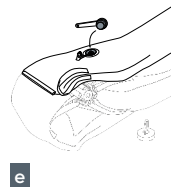
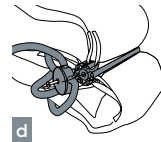
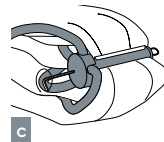
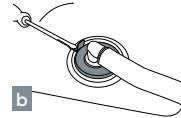
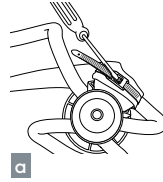



## 10.4 REMOVING TUBES

The four tubes can be separated from each other at the tube intersection at the top of the tent.

### 10.4.1 XD 4/5/6/7

- First, separate the roof from the tubes - see section 10.2.

#### IF THE TENT IS EQUIPPED WITH THE ONE-PUMP SYSTEM:

- Open the hex socket screw which fastens the air distributor (a) and remove the air distributor (a/b).
- Detach the relief straps from the 'aluminum profile' (c).
- Slide the tubes out of the 'aluminum profile' (d).

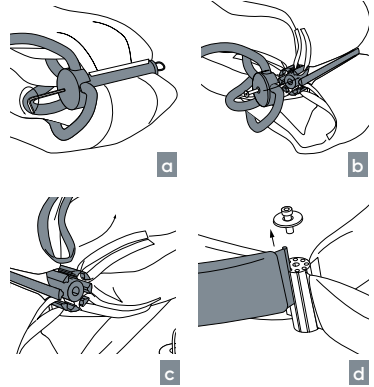

### 10.4.2 XC 3

- First, separate the roof from the tubes - see section 10.2.
- Unscrew the hex socket screw from the tube connector and remove the screw and cap (a).
- Slide the tube ends out of the 'aluminum profile' (b).

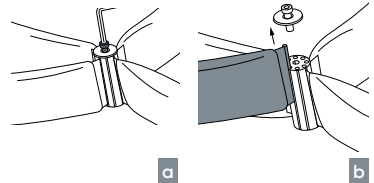

## 10.5 REASSEMBLING THE ROOF AND TUBES

Reassemble the roof and tubes by following the steps listed in the previous Removal/Disassembly sections in reverse (d-a).

## 10.6 REPLACING THE PROTECTION STRIPS

### 10.6.1 XC 3

A protection strip is attached with velcro to each tube end of the tent. To replace, simply remove and attach the new one.

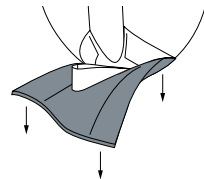

## 10.7 IN THE EVENT OF PRESSURE LOSS

- **FIRST**, be sure that all valves are closed tightly!
- If pressure loss continues, blow out the overpressure valves while pushing the spring on the inside to remove any dust or dirt particles.
- If the tube continues to lose air pressure, we recommend removing and replacing
- the bladder, as it is likely damaged.
- To help locate a small hole in the bladder, it can help to spray the surface of the inflated bladder with soapy water, so that escaping air bubbles can be easily seen. Alternatively, the bladder can be filled with a small amount of water so that water drops forming can help identify the hole.
- If the damage to the bladder can be located and the length of damage is smaller than 1 cm, then it can be patched using an adhesive repair patch.

## 10.8 REPAIRING A BLADDER

The adhesive repair patches resist perforation and elongation, and have been developed especially for repairing tears and holes in the bladder.

- Clean all dirt and oil from the area to be repaired using the included cleaning cloth (a).
- Trim the adhesive repair patch to the necessary size and carefully remove the protective film. Take care to avoid touching the adhesive surface (b).
- Press the repair patch onto the repair area and make sure that it sufficiently overlaps the damage. An overlap of at least 20 mm is recommended for larger tears or holes.
- Press the repair patch onto the bladder uniformly and firmly in order to achieve a strong immediate adhesion. The final adhesive strength will be reached after a few hours (c).
- Wait several minutes for the repair patch to dry before continuing to use the bladder (d).

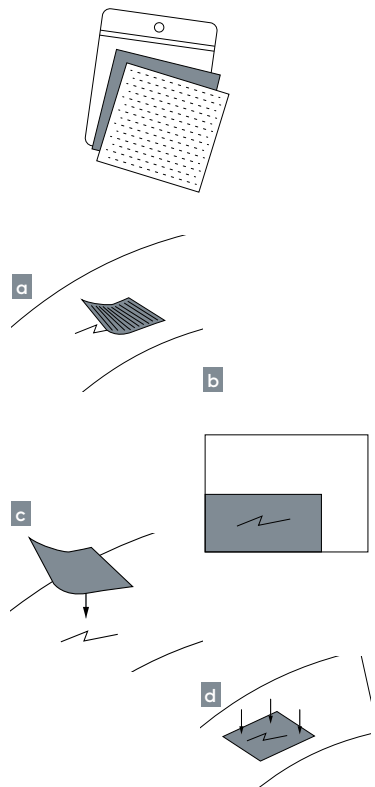

## 10.9 REPLACING A VALVE

- With XD tents, only the overpressure valve can be unscrewed by hand (a), while the inflation/deflation valve can only be removed from its socket using a special key (a). To do this, while holding the tube, grip the socket from the back in order to be able to achieve the torque needed to unscrew the valve. Be careful to avoid damaging the air bladder that is necessarily gripped at the same time.
- With the XC tent, the valves can be easily unscrewed from the sockets by hand (b).

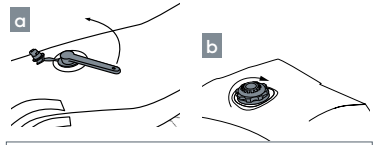

**TIP:** Wrinkles that form in the bladder during the first time it is inflated can be visible from the outside. To avoid this, shake the tube while inflating it and run your hand along any wrinkles as they form to smooth them out. Continue until the tube is completely inflated.

## 10.10 REPLACING A BLADDER

### 10.10.1 XD 4/5/6 /7

- Lay out the tent so the damaged tube is on top so that you have easy access to it (a).
- Remove the aluminum profile on the bottom tube end. To do this, use an Allen key to remove the screws on both sides of the profile and pull the steel sleeves out of the profile. Slide the profile off of the tube end (b/c/d).
- Slide the tube out of the profile on the tube end intersection by first using an Allen key to remove the One-Pump System (if equipped), then unscrewing the closing cap from the opposite end of the profile, and finally sliding the webbing loops and tube end out of the profile (welt system) (e/f/g).
- Use the valve wrench to unscrew the inflation/deflation valve at the lower end of the tube (h) as well as the valve connecting the One-Pump System at the top of the tube (if equipped) (i) and detach velcro holding the valve socket to the tube.
- Push the overpressure valve through to the inside of the tube (attached with velcro) (j)

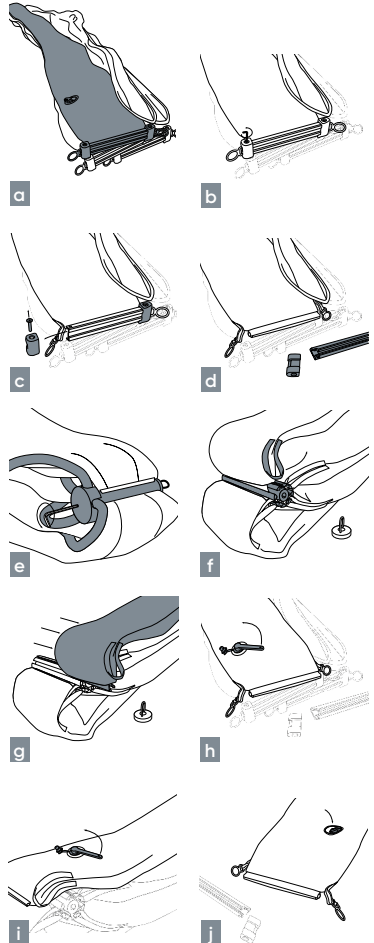

- The bladder is now completely free from the tube and can be pulled out of the opening on either end (k).
- Lay the replacement bladder facing the top end of the tube, making sure that it is arranged with the correct side facing up – observe the position of the valves on the bladder and the tube (l) so that when the bladder is pulled into the tube, the valves are in the correct locations. Once the bladder is so arranged, unscrew and remove the valves (m).
- Starting at the opening at the bottom end of the tube, thread the entire tube onto your arm until you can grasp the end of the replacement bladder through the opening at the top end of the tube. Pull the replacement bladder into the tube, making sure that it does not become twisted. Continue to pull the bladder into the tube until the bladder extends slightly out of both openings in the tube. It can help to have someone assist you with this step (n).
- Push the overpressure valve on the replacement bladder through the corresponding opening in the tube and press to close the velcro. Be careful that none of the bladder material gets pinched between the velcro on the valve.
- Attach the velcro ring on the socket for the inflation/deflation valve to the velcro around the corresponding opening on the tube (o).
- Use the valve wrench to screw the inflation/deflation valve at the bottom tube end firmly into place (p).
- The inflation valve for the One-Pump System at the top of the tube can be screwed in using the valve wrench supplied with the tent. When screwing the valve back in, it is essential to screw it in as far as possible. This requires some extra force to be applied. Make sure that the final position of the valve is not random. Instead, make sure that the two notches on the outside edges of the valve are facing the tube ends (q).
- Mount the air distributor and end cap (r) on the upper end of the tube using a hex socket screw (r).
- Slide the bottom tube end into the aluminum profile and the welts on the top tube end into the channels in the tube connector. While doing so, don't forget to also slide the small welts on the bladder into the provided recesses of the welts on the tube end (s).
- Connect the webbing straps found at the inside and outside of the bottom tube end to the aluminum profile by inserting the steel sleeve and fastening it in place with the hex socket screw (t/u).

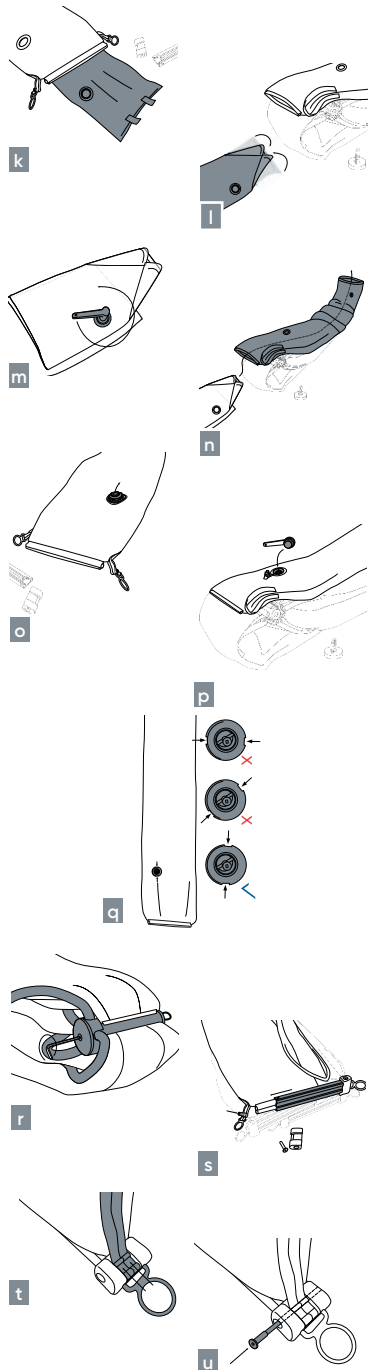

## 10.10.2 XC 3

- Lay out the Tent so that the damaged tube is on top and that you can easily access the service zipper.
- Open the two velcro straps which connect the tube to its neighbors at the tube intersection (a).
- Open the service zipper at the top of the tube (b).
- Detach the velcro which connects the end of the bladder to the inside of the tube (c) and slide the end of the bladder out of the service opening (d).
- Next, open the service zipper at the bottom end of the tube (e).
- Detach the velcro connecting the bladder to the inside of the tube in the same manner as before (f).
- Push/pull both valves into the tube (g). The valves are secured on the inside with velcro.
- Now you can pull the bladder out through the service opening back at the bottom end of the tube (h).
- Lay the replacement bladder at the bottom end of the tube, making sure that it is arranged with the correct side facing up and the valves oriented correctly (i).
- Starting at the service opening at the top end of the tube, thread the entire tube onto your arm until you can grasp the end of the replacement bladder through the opening at the bottom end of the tube (j).
- Pull the replacement bladder into the tube, making sure that it does not become twisted. Continue to pull the bladder into the tube until the bladder extends slightly out of both openings in the tube (k). It can help to have someone assist you with this step.
- Push the valves on the replacement bladder through the corresponding opening in the tube and press to close the velcro. Be careful that none of the bladder material gets pinched between the velcro on the valve (l).
- Precisely attach the velcro on both ends of the bladder to the velcro on the inside of the tube (m).
- Close the service zippers on both ends of the tube (n).
- Before inflating the new bladder for the first time it needs to be spread out evenly inside the tube. To achieve this, two people hold the ends of the tube as it lays on the ground and gently pull on them while shaking the tube at the same time (o).

